

MANUAL

Field Current Controller

F2.2



Stegmaier-Haupt GmbH
Industrieelektronik-Servoantriebstechnik
Untere Röte 5
D-69231 Rauenberg
Tel.: 06222-61021
Fax: 06222-64988
Email: info@stegmaier-haupt.de
Http: // www.stegmaier-haupt.de

Edition / Version

05/2016 V 02

1	Contents	
2	Basic information	3
2.1	Safety regulations	3
2.2	Regulations and guidelines	3
2.3	General information and features	5
2.4	Technical data	6
2.5	Common specification	6
3	Mechanical installation	7
3.1	Dimensions F2 – 12A	7
3.3	Dimensions F2 – 20 A	8
4	Electrical installation	9
4.1	Field current controller settings	9
4.2	Connection diagram - field current controller	9
4.3	Enable	10
4.4	Command value	10
4.5	Command value via a potentiometer	10
4.6	Command value with external voltage	11
4.7	Command value current	11
4.8	Command value reduction	11
4.9	Field current signal	11
4.10	Field current display	11
4.11	LED Display	12
4.12	Current setting	12
4.13	Max. field current	12
4.14	Min. field current	12
4.15	Command value reduction	12
4.16	Field current signal	13
5	Electrical installation	14
5.1	Transfer circuit connections	14
5.2	Transfer circuit connection diagram	14
5.3	Armature voltage connection	14
5.4	Enable	15
5.5	Field current signal	15
5.6	Basic settings	15
5.7	Current setting	15
5.8	Max. field current	16
5.9	Min. field current	16
5.10	Transfer triggering point	16

- 5.11 Transfer triggering point setting 16
- 5.12 Control dynamics setting 17
- 5.13 Function of the contacts 17
- 5.14 Setting of the contacts at switch S1 17
- 5.15 Setting 17
- 6 Guarantee 18**



2 Basic information

2.1 Safety regulations

In principle electronic equipment is not fault proof!

Caution - High voltage
AC 400V~, DC 560V=
Shock hazard! / Danger to life!!



Before installation or commissioning begins, this manual must be thoroughly read and understood by the skilled technical staff involved. If any uncertainty arises, the manufacturer or dealer should be contacted.

The devices are power electric parts (EB) used for regulating the energy flow in high-voltage systems.

Protection rating IP00.

The control and power connections may be voltage-carrying without the axis operating!
Measure the voltage prior to any disassembly!



2.2 Regulations and guidelines

The devices and their associated components can only be installed and switched on where the local regulations and technical standards have been strictly adhered to.

EU Guidelines	2004/108/EG, 2006/95/EG, 2006/42/EG EN 60204-1, EN292, EN50178, EN60439-1, EN61800-3, ECE-R100 ISO 6469, ISO 26262, ISO 16750, ISO 20653, ISO12100
IEC/UL:	IEC 61508, IEC364, IEC664, UL508C, UL840
VDE Regulations/TÜV Regulations:	VDE100, VDE110, VDE160
Regulations of the statutory accident insurance and prevention institution:	VGB4

The user must ensure that in the event of:

- device failure
- incorrect operation
- loss of regulation or control

the axis will be safely de-activated.

It must also be ensured that the vehicles, machines, equipment, or vehicles are fitted with device independent monitoring and safety features.

Unearthed systems (e.g. vehicles) must be protected by means of independent insulation monitors.

Man as well as property must not be exposed to danger at any time!



Assembly

- should only be carried out when all voltages have been removed and the units are secured
- should only be carried out by suitably trained personnel

Installation

- should only be carried out when all voltages have been removed and the units are secured
- should only be carried out by suitably trained personnel for electricians
- should only be carried out in accordance with health and safety guidelines

Adjustments and programming

- should only be carried out by suitably trained personnel with knowledge in electronic drives and their software
- should only be carried out in accordance with the programming advice
- should only be carried out in accordance with safety guidelines

CE

When mounting the units into vehicles, machines, and installations the proper operation of the units may not be started until it is ensured that the machine, the installation, or the vehicle comply with the regulations of the EC machinery directive 2006/42/EG, the EMC guideline 2004/108/EG, and the guideline ECE-R100.

On the described installation and test conditions (see chapter 'CE notes') it is adhered to the EC guideline 2004/108/EG including the EMC standards EN61000-2 and EN61000-4.

A manufacturer's declaration can be requested.

The manufacturer of the machine or installation is responsible for observing the threshold values demanded by the EMC laws.

QS

Test results are archived with the device serial number by the manufacturer for a period of 5 years.

The test protocols can be asked for.

2.3 General information and features

The field controller F2.xx is used as field current controller or field current transfer controller.

For the field current controller the field current is controlled to the applied command value. The field current command value is internally halved via the reduction input (stand-by) in order to save field energy when the machine is stationary.

The control electronics is internally isolated from the power section.

For field current triggering control the field current is controlled by means of the armature voltage of the motor.

At constant field current the armature voltage increases with the speed up to the triggering point, then the armature voltage remains constant and the field current is reduced.

In the first section the torque remains constant with the power increasing. In the second section the power remains constant with the torque decreasing.

The armature voltage of the main current controller is coupled to high impedance via a differential amplifier.

The leakage current to PE is inferior to 1mA.

The field current is monitored by means of an adjustable current sensor.
If the field current is inferior to the value set by means of the potentiometer, the signal relay opens.

The power semiconductors are fully insulated. The heat sink is protected against accidental contact.

2.4 Technical data

Unit type	F2.xx	230/180-12	230/180-20	400/340-12	400/340-20
Max. power supply voltage	V~	230	230	400	400
Auxiliary voltage	V~	230	230	400	400
Max. output voltage	V=	180	180	340	340
Max. input current	A~	13,2	22	13,2	22
Max. output current	A=	12	20	12	20
Auxiliary voltage fuses	AT	0.8	0.8	0.8	0.8
Power supply voltage fuses	Aff	Int.16	Ext.25	Int.16	Ext. 25
Dimensions	mm	190x140x73	206x160x112	190x140x73	206x160x112
Weight	kg	1.0		1.0	

2.5 Common specification

Mains frequency	50 or 60 Hz ±5%
Protection rating	IP00
Format	VDE 0100 group C
	VDE 0160
Humidity rating	class F acc. to DIN 40040
Site of installation	< 1000m above sea level
Operating temperature range	0 ... 45°C
Extended operating range	up to 60°C reduced by 2 %/°C
Storage temperature range	-30°C to +80°C

3 Mechanical installation

3.1 Dimensions F2 – 12A

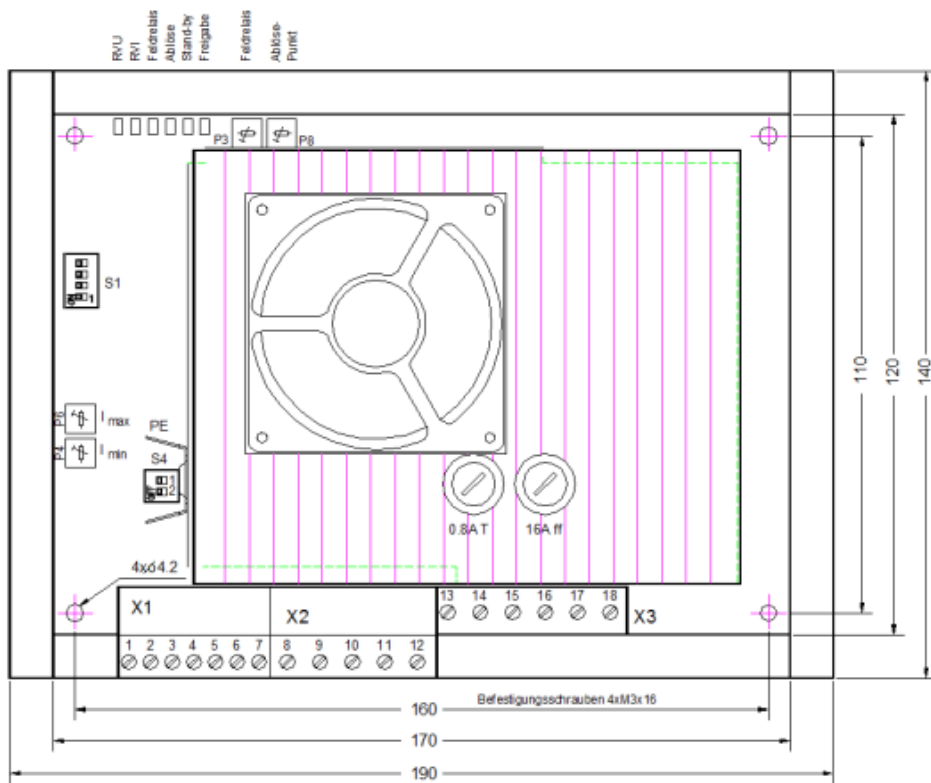
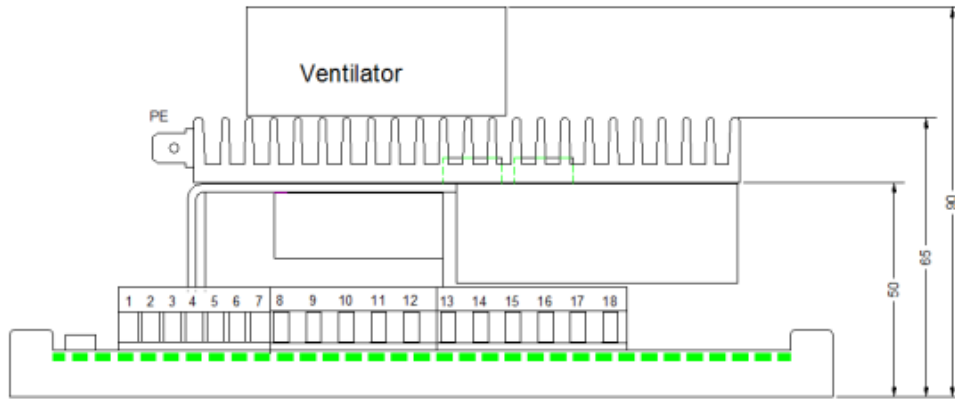

F2-M1086-12-2o.R.

3.3 Dimensions F2 – 20 A

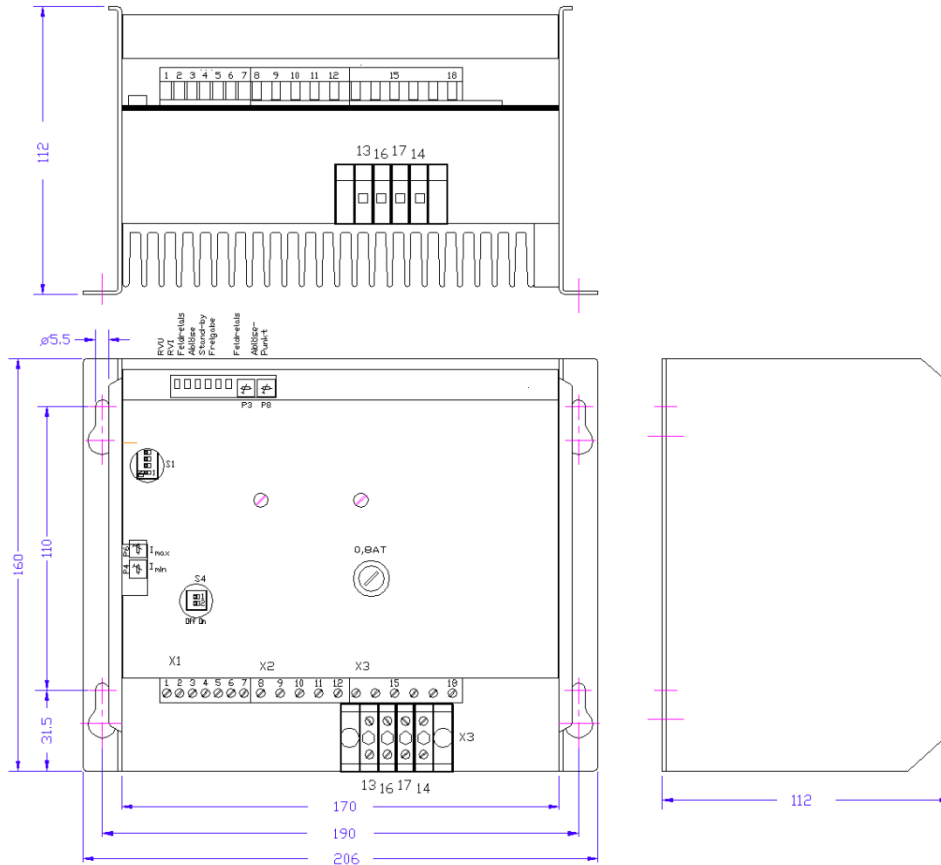

F2-M1088-20-2

4 Electrical installation

4.1 Field current controller settings

For field current control the potentiometer P8 must be set to left full scale.

Switch	S1	contact 1-4	=	ON
Switch	S4	contact 1	=	ON
		contact 2	=	OFF

The command value voltage of 0...12V corresponds to a field current of 0...12A (20A). A min. current of up to 1A can be adjusted by means of the potentiometer I_{min} .

4.2 Connection diagram - field current controller

The control electronics is potential-free.

Field regulator
Feldregler

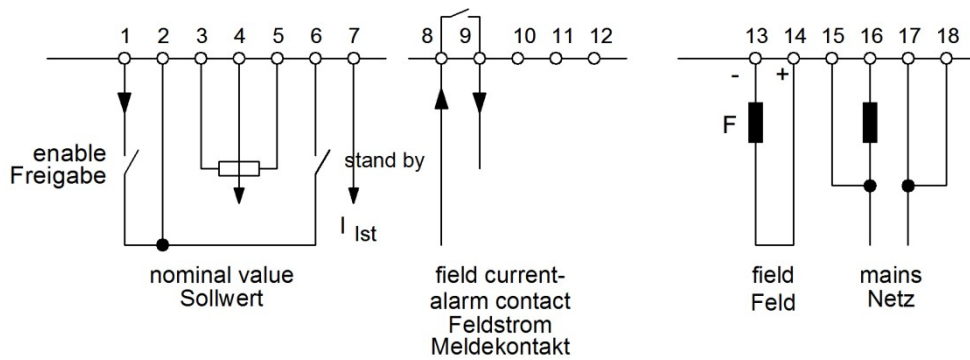

ED-F"-A1087-2-Feldstrom

Connection via a transformer for low or high field voltages

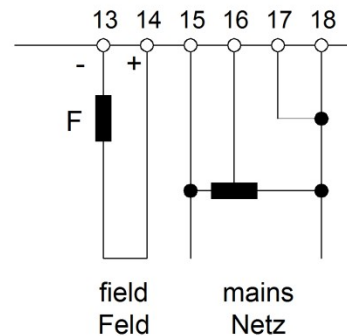

ED-F2-A1087.2-trafo

4.3 Enable

The field controller is enabled by switching the output X1:1 to X1:2 via a relay contact or by applying a switching voltage >10V ... 30V= across GND X1:5. The enable is indicated by the LED D13 FRG.

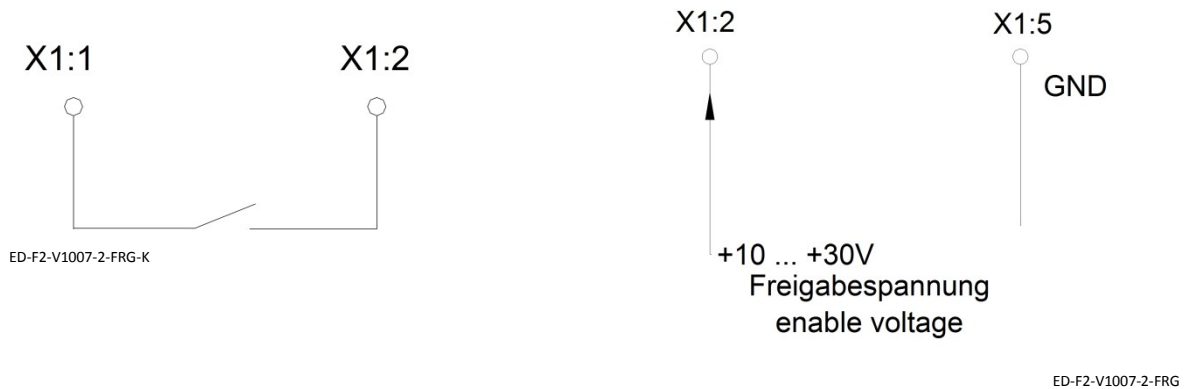

4.4 Command value

The command value can be entered by means of a potentiometer with internal supply or by applying an external voltage.
 Resistance value of the potentiometer 5...10kΩ
 Max. external voltage +12V

4.5 Command value via a potentiometer

The potentiometer is connected across X1:3 (+12) and X1:5 (GND). The center tap is connected to the command value input X1:4. A command value of 0...12V corresponds to a field current of 0...12 A (20 A).

The set value of X1:4 can internally be reduced by means of the potentiometer P6 I_{max}1.

For a fixed setting X1:3 is connected with X1:4 and the command value is adjusted only by means of the Poti P6 I_{max}1.

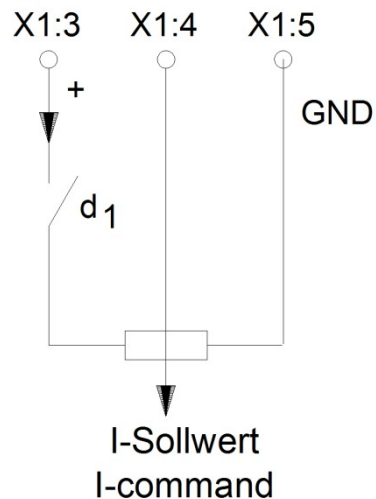

ED-F2-V1007-2-Soll

4.6 Command value with external voltage

It is possible to apply a voltage signal 0...+12V across the command value input X1:4 and GND X1:5.

Input resistance: 57kΩ

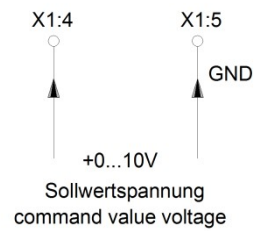

4.7 Command value current

In order to transform a current command value of 0...20mA a resistance Ri of 600Ω must externally be connected between X1:4 and X1:5.

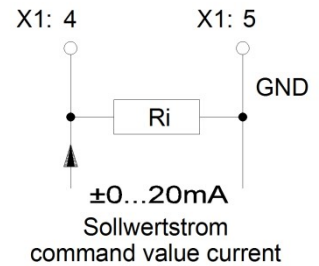

4.8 Command value reduction

The applied current command value is halved (standby circuit) by closing a contact between X1:1 and X1:6 or by applying a voltage of 10...30 V= across X1:6 referred to X1:5.

The function is indicated by LED D11.

The min. field current is not affected.

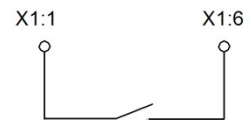

4.9 Field current signal

Internal relay contact between X2:8 and X2:9 for max. 60V/0.5A.

The field current signal can be adjusted within 10...100% of the field current.

The relay d1 closes when the field current exceeds the set value.

When the relay is closed the LED D5 is lit.

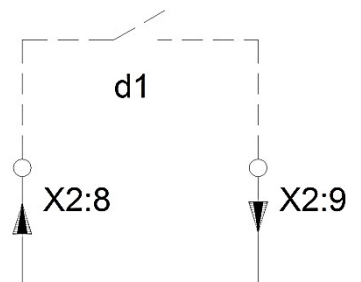

4.10 Field current display

It is possible to connect a display element for the field current at the output X1:7 against X1:5.

The measuring value is 5.5 V for 12 A field current

or 4.6 V for 20 A field current

Output resistance 10kΩ

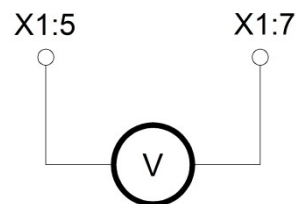

4.11 LED Display

LED	Function	Display
D1RVU:	The brightness indicates the magnitude of the current command value	dark = 0 V / bright = 10 V
D2RVI:	The brightness indicates the control angle of the current controller	dark = low field voltage bright = high field voltage
D5:	Field current signal	bright = Field current > adjusted threshold at P3
D7 I-AB:	Field current command value via triggering transfer switch	bright = high field current, not triggered
D11 I-red:	Standby circuit	bright = reduce current via standby
D13 FRG:	Enable	bright = enable

4.12 Current setting

Set potentiometer P8 to left full scale!

First set the max. field current value then set the min. value. If the command value setting is fixed X1:3 and X1:4 can be bridges.

4.13 Max. field current

Set potentiometer P4 I_{min} to left full scale.

At enable and max. command value the max. field current minus the min. field current is adjusted by means of the potentiometer P6 I_{max} .

The field current increases by turning the poti clockwise.

Example:

Max. field current 8 A

Min. field current 2 A

Adjusted value by means of poti P6 $I_{max} = 6$ A

4.14 Min. field current

At enable and command value 0V a min. field current of 0 to 30% of the rated current is adjusted by means of the potentiometer P4 I_{min} .

The min. field current increases by turning the poti clockwise.

4.15 Command value reduction

The applied current command value is halved by closing a contact between X1:1 and X1:6 or by applying a voltage of 10 to 30 V= across X1:6 refered against X1:5.
(Standby circuit).

The function is indicated via the LED D11.

The min. field current is not affected.

4.16 Field current signal

Adjust the field current to 80 % of the min. permissible field current.

Set the potentiometer P3 to right full scale.

The relay must open. LED D5 'field relay' must be dark.

Turn potentiometer P3 anti-clockwise until the relay attracts and the LED D5 'field relay' lights up.

5 Electrical installation

5.1 Transfer circuit connections

For a combined armature field control the motor is operated within the armature control range until the transfer triggering point is reached. Then it is operated within the field weakening range. That is, up to the triggering point there is a constant torque available with an increasing power. From the triggering point on there is a constant power with a decreasing torque available. This is due to the field weakening.

5.2 Transfer circuit connection diagram

Connection diagram transfer circuit
Ablöseschaltung

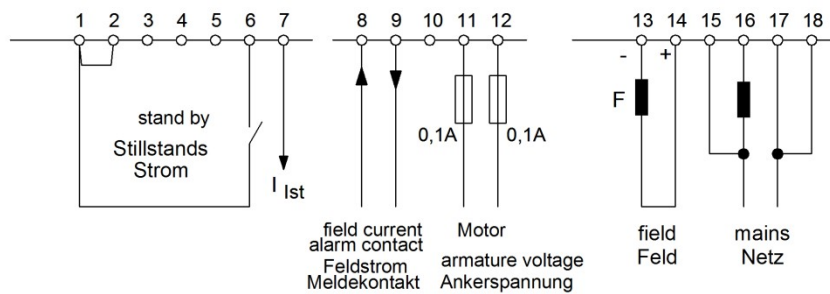

ED-F2-A1087-2-Ablöse

5.3 Armature voltage connection

The armature voltage is connected across X2:11 and X2:12. The max. supply voltage is ± 450 V. The connection must be protected directly at the tapping point by 0.1A. The armature voltage input is a high-impedance differential amplifier with a leakage current of 1mA.

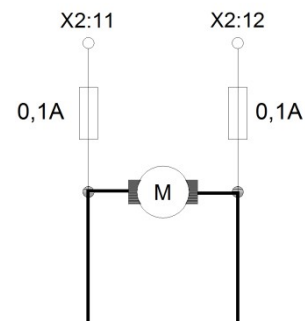

ED-F2-A1087-2-trafo

5.4 Enable

The enable input X1:2 is directly bridged with the voltage output X1:1.

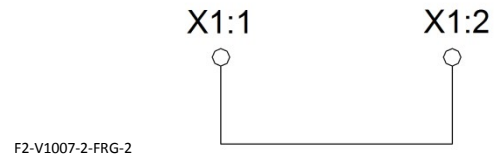

5.5 Field current signal

Internal relay contact between X2:8 and X2:9 for max. 60V/0.5A.

The field current signal can be set between 10 and 100% of the field current.

The relay attracts when the field current is superior to the set value. The LED D5 is bright when the relay is attracted.

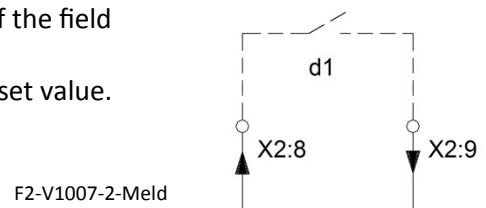

Note:

The armature converter must only be enabled when the field current relay is closed.



5.6 Basic settings

Switch S1: contact 1= ON, contacts 2,3,4 = OFF

Switch S4: contact 1= ON, contact 2 = OFF

5.7 Current setting

First adjust the max. field current then adjust the min. one.

5.8 Max. field current

Motor controller not enabled, armature voltage 0V.

Potentiometer P4 I_{\min} at left full scale. Potentiometer P8 at right full scale.

The max. field current minus the min. field current is adjusted by means of the potentiometer P6 I_{\max} .

The field current increases by turning the poti clockwise.

Example:

Max. field current 8A

Min. field current 2A

Adjusted value by means of poti P6 $I_{\max} = 6A$

5.9 Min. field current

Potentiometer P8 at left full scale. The min. field current is set between 0 and 30% of the rated current by means of the potentiometer P4 I_{\min} .

The min. field current increases by turning the poti clockwise.

5.10 Transfer triggering point

The triggering point can be set between 0 and $\pm 400V$ by means of the potentiometer P8 UA.

The triggering point is indicated by means of the LED D7.

5.11 Transfer triggering point setting

Set potentiometer P8 to right full scale.

Increase the motor speed until the armature voltage exceeds the adjusted transfer triggering point by 5%.

Turn the potentiometer P8 anti-clockwise until - at constant speed - the armature voltage has fallen to the set transfer voltage.

Example:

Set potentiometer P8 to right full scale.

Increase the speed command value at the motor controller until the armature voltage reaches 420V.

Turn potentiometer P8 anti-clockwise until the armature voltage has fallen to 400V.

Now the transfer triggering point is at 400V armature voltage.

5.12 Control dynamics setting

The control behaviour of the transfer control is set by means of the switch S1.
Basic setting S1: contact 1=ON, contacts 2, 3 and 4 = OFF

5.13 Function of the contacts

Contact 1 and 2 capacitor I-term
Contact 3 and 4 resistance P-term

5.14 Setting of the contacts at switch S1

P values	Amplification	K3	K4
150kΩ	3	OFF	OFF
60kΩ	1.2	OFF	ON
36kΩ	0.8	ON	OFF
26kΩ	0.5	ON	OFF

I-Werte	K1	K2
0.20μF	OFF	OFF
0.67μF	ON	OFF
1.14μF	OFF	ON
1.61μF	ON	ON

Integral time constant P value x I value x 4

5.15 Setting

Measure the armature voltage.
Speed step exceeding the transfer triggering point.
The armature voltage may overshoot by approx. 10%.

If the armature voltage overshoots more than 10%	>>>	Increase the amplification and reduce the I value.
If the armature voltage overshoots continuously	>>>	Increase the I value.

6 Guarantee

We guarantee that the device is free from material and production defects. Test results are recorded and archived with the serial number.

The guarantee time begins from the time the device is shipped, and lasts one year. WE undertakes no guarantee for devices which have been modified for special applications.

During the warranty period, we will, at its option, either repair or replace products that prove to be defective, this includes guaranteed functional attributes. We specifically disclaim the implied warranties or merchantability and fitness for a particular purpose. For warranty service or repair, this product must be returned to a service facility designated by us.

For products returned to us for warranty service, the Buyer shall prepay shipping charges to us and we shall pay shipping charges to return the product to the Buyer.

However, the Buyer shall pay all shipping charges, duties, and taxes for products returned to us from another country.

The foregoing warranty shall not apply to defects resulting from:

- * improper or inadequate repairs effected by the Buyer or a third party,
- * non-observance of the manual which is included in all consignments,
- * non-observance of the electrical standards and regulations
- * improper maintenance
- * acts of nature

All further claims on transformation, diminution, and replacement of any kind of damage, especially damage, which does not affect our device, cannot be considered. Follow-on damage within the machine or system, which may arise due to malfunction or defect in the device cannot be claimed.

This limitation does not affect the product liability laws as applied in the place of manufacture (i. e. Germany).

We reserve the right to change any information included in this MANUAL.

All connection circuitry described is meant for general information purposes and is not mandatory.

The local legal regulations, and those of the Standards Authorities have to be adhered to. We do not assume any liability, expressively or inherently, for the information contained in this MANUAL, for the functioning of the device or its suitability for any specific application.

All rights are reserved.

Copying, modifying and translations lie outside our liability and thus are not prohibited. Our products are not authorised for use as critical components in the life support devices or systems without express written approval.

The onus is on the reader to verify that the information here is current.